

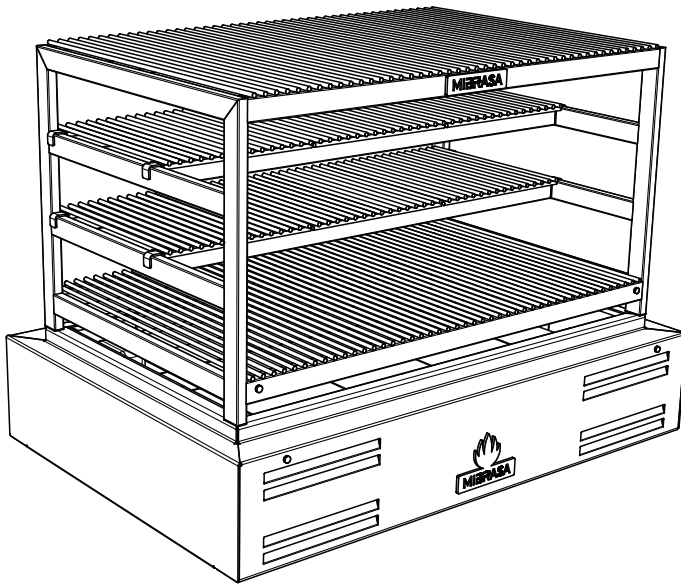

MIBRASA® ROBATA BEAST USER MANUAL



**READ ALL INSTRUCTIONS BEFORE INSTALLING AND USING THE APPLIANCE.
SAVE THESE INSTRUCTIONS.**

A MAJOR CAUSE OF PARRILLA-RELATED FIRES IS FAILURE TO MAINTAIN REQUIRED CLEARANCES (AIR SPACES) TO COMBUSTIBLE MATERIALS. IT IS OF UTMOST IMPORTANCE THAT THIS PARRILLA BE INSTALLED ONLY IN ACCORDANCE WITH THESE INSTRUCTIONS.

The Craftsmen of Fire!

www.mibrasa.com

Mibrasa.

The Craftsmen of Fire!

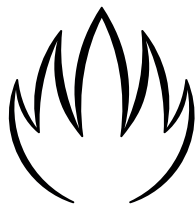

We are fascinated by fire and invite you to experience grill cooking for yourselves. Cook and create in a way that awakens your taste buds and remind us of the beauty in simplicity.

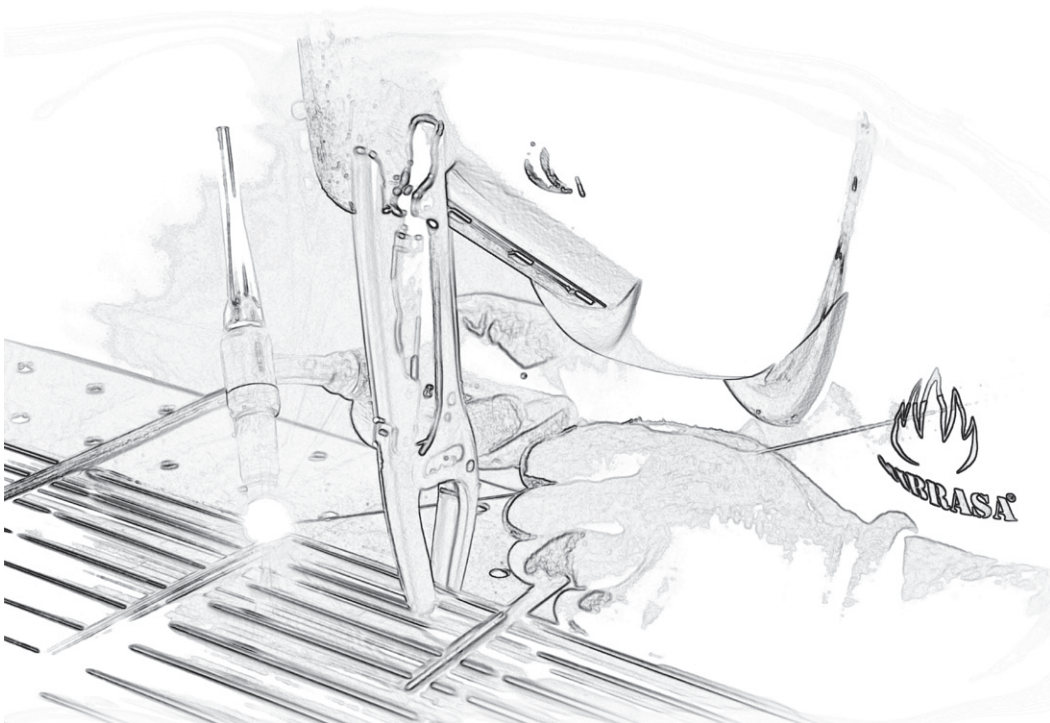

Contents

1. Introduction	1
2. Safety standards and dangers	2
3. Mibrasa® RM Beast dimensions	3
4. Parts of the Mibrasa® RM Beast	5
5. Installation instructions	7
5.1. Installation guidelines and safety standards	
6. Lighting up	8
7. Maintenance and safety standards	9
7.1 Daily cleaning	
7.2 Special care	
8. General conditions	10
8.1 Warranty	
8.2 Returns	
8.3 Property Reserve	

1. Introduction

The Mibrasa® Robata Beast is conceptualized and engineered for chefs in need of high production and versatility.

Experiment with levels, temperatures and position of the grills to apply infinite cooking techniques at the same time. It lets us sear, cook and rest our ingredients, achieving the optimal result every time.

The Mibrasa® Robata Beast is manufactured with steels of the latest technology following the most rigorous quality controls. Like all Mibrasa® units, they comply to the strict standards & regulations set by internationally recognized certifications of quality.



Our Robata Beast

Equipped with 4 fixed levels, each of which offers extense, adaptable and removable cooking surfaces that allow you to cook multiple ingredients.

Execute varied cooking techniques from direct, vertical, skewer and spit-roast, among others to suit all types of gastronomy.

Guarantee maximum heat efficiency and a higher burning capacity of charcoal or firewood thanks to the base pit lined with refractory bricks.

Please read this entire manual before you install the Mibrasa® Robata Beast.
Failure to follow instructions may result in property damage, bodily injury, or even death.

2. Safety standards

- Only use charcoal in the Mibrasa® Robata Beast
- The first time the Mibrasa® Robata Beast is used do not cook food for at least one hour after lighting.
- Proceed with reasonable care when operating a Mibrasa® Robata Beast. Never leave it unattended when lit.
- **CAUTION** Do not overload/fire. Consult the charcoal loads in the chart in point 6
- Disposal of ashes – Ashes should be placed in a metal container with a tight-fitting lid. The closed container of ashes should be placed on a non-combustible floor or on the ground, well away from all combustible materials, pending final disposal. When the ashes are disposed by burial in soil or otherwise locally dispersed, they should be retained in the closed container until all cinders have thoroughly cooled.
- Do not attempt to pour water over the hot coals.
- Do not clean the Mibrasa® Robata Beast when it is in operation or hot.
- Do not use chemical products to clean the exterior of the Mibrasa® Robata Beast when in use or hot.

DANGERS

- If the Mibrasa® Robata Beast is not correctly installed, a fire may result. To reduce the risk of fire, follow the installation instructions.
- Keep children and pets away from the oven and flammable products. Accessible parts of the Mibrasa® Robata Beast may be very hot.
- Do not use alcohol, oil or other liquids similar to ignite or rekindle hot coals. Use only Mibrasa® ecofire firelighters.
- In the case of installing the Mibrasa® Robata Beast in an outdoor setting, do not cover it with any type of protective cover or inflammable material when it is in operation or hot.
- Read the restrictions in point 5.1 on minimum distances from combustible materials.

3. Mibrasa Robata Beast dimensions

RM 100 BEAST

Dimensions in inches and [mm]

FRONT VIEW

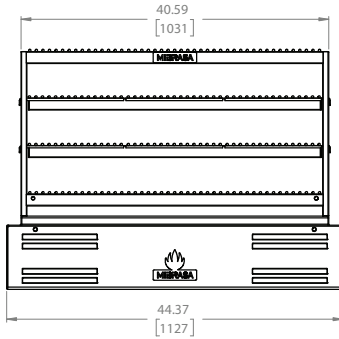

SIDE VIEW

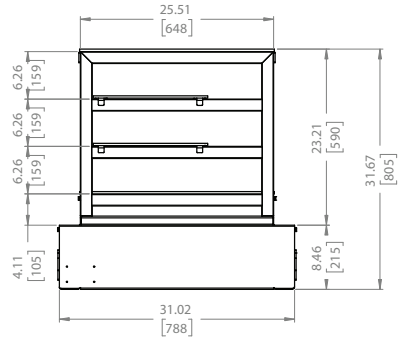

TOP VIEW

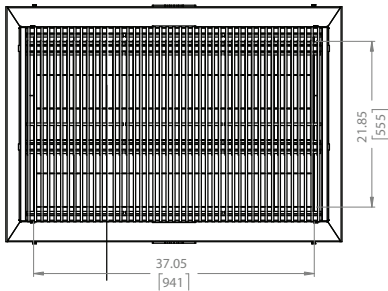

Size of useful surface area of top and lower grills

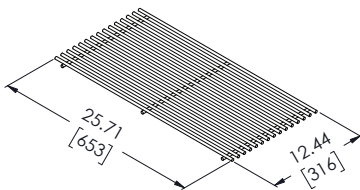

Size of useful surface area of middle grills

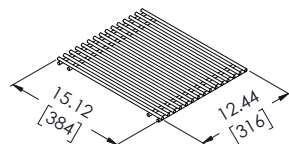

RM 100 BEAST with complete stand (MCGMB100)

Dimensions in inches and [mm]

FRONT VIEW

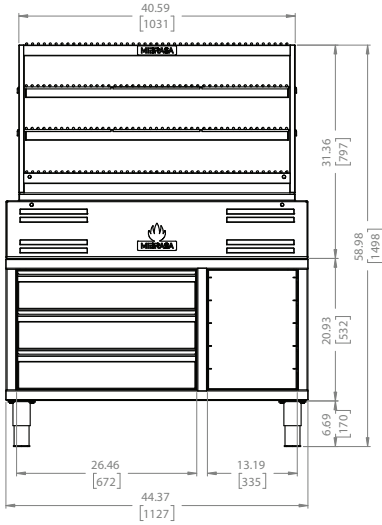

SIDE VIEW

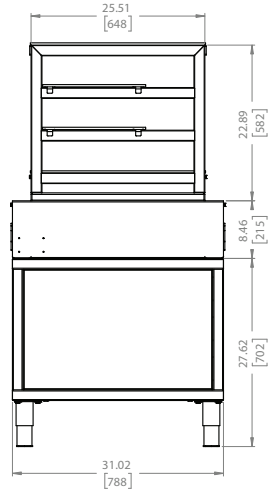

RM 100 BEAST with stand (MGMB100)

FRONT VIEW

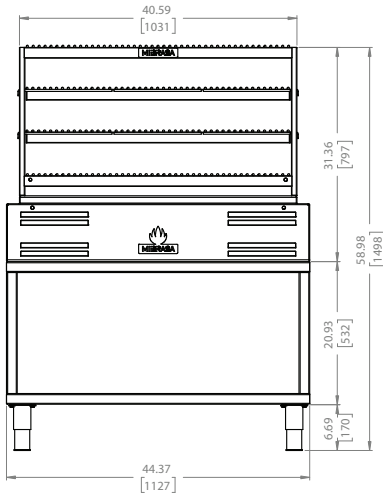

SIDE VIEW

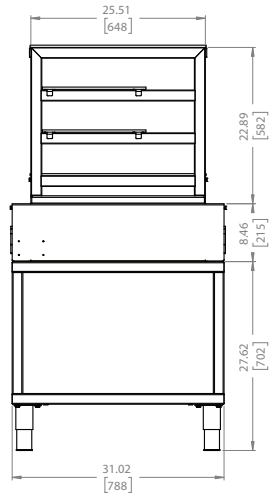

The Mibrasa® Robata Beast is subject to technical and design changes.

4. Parts of the Mibrasa® Robata Beast

1. Structure

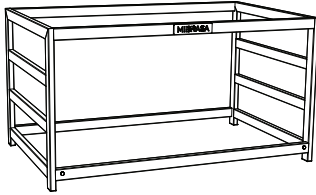

2. Burning pit base

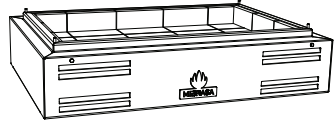

3. Support bars

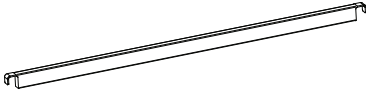

4. Refractory bricks



5. Top and lower grill

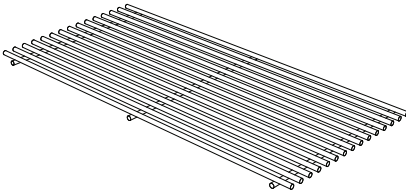

6. Middle grill

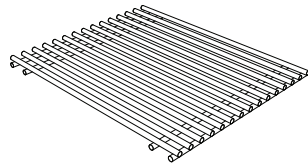

Included accessories

Top and Lower grills (x6)

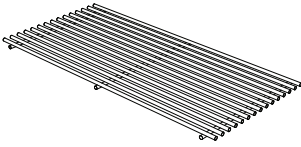

Middle grills (x6)

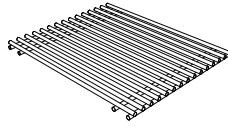

Mibrasa tongs

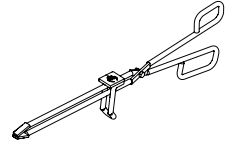

Ash shovel

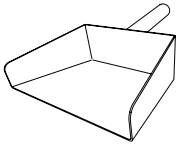

Ember poker

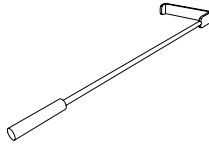

Grill brush

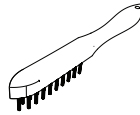

Mibrasa Ecofire firelighters

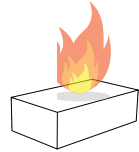

Optional accessories

Top and lower grill

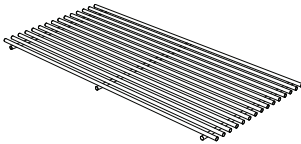

Middle grills

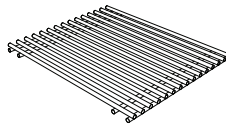

Stand/Complete stand

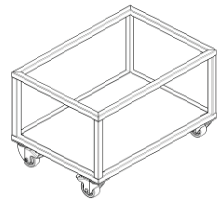

S/S lid

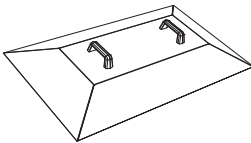

Spit-roast

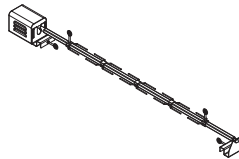

Kitchenware & Grillware



(consult our catalogue
at www.mibrasa.com)

5. Installation instructions

1 Remove grills and support bars

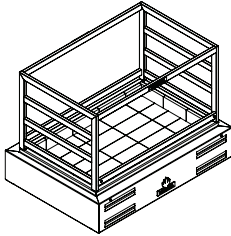

2 Lift and remove structure

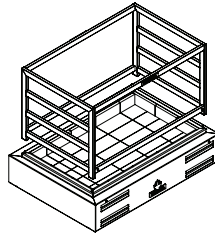

3 Place main body on top of work table or stand

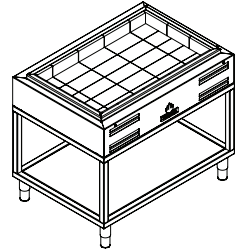

4 Replace structure

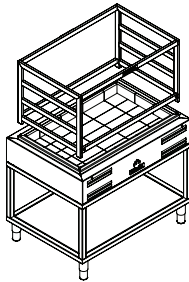

5 Replace grills and support bars

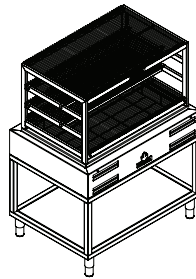

6 Ready to cook,

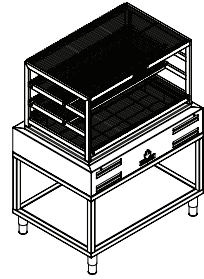

5.1 Installation and safety standards

The installer should contact the local building or fire officials concerning any installation restrictions or need for inspection of the Mibrasa® Robata Beast installation.

- Clearances to construction:
Unit to backwalls: 7 in (180 mm)
Unit to sidewalls: 28 in (720 mm)
- Workspace for the chef and recommended height of the worktop [see image].

Workspace for the chef and recommended worktop height.

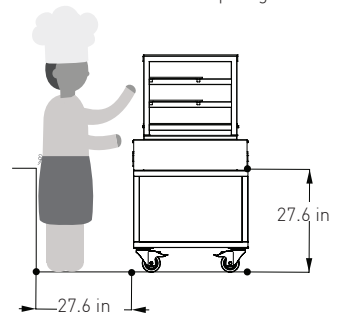

Ventilation recommendations

Model	Flow rate (gal/s)	Hood dimensions (Width x depth in inches)	Minimum height of hood from floor (in)
RM 100	300	59.05 x 51.18	78.74

6. Lighting up

1 Remove grills and load charcoal

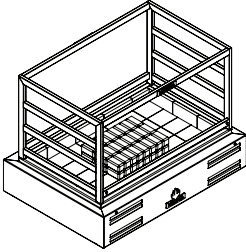

2 Place and light Ecofire firelighters

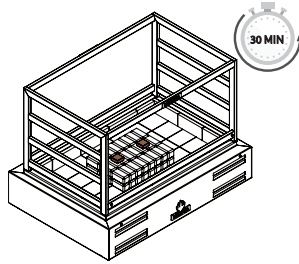

3 Spread embers

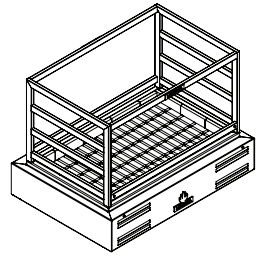

Always light the charcoal inside the refractory-lined hearth

5 Replace grills

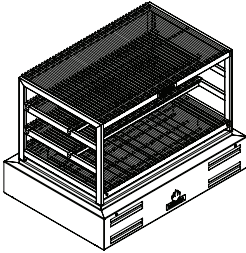

6 Ready to cook

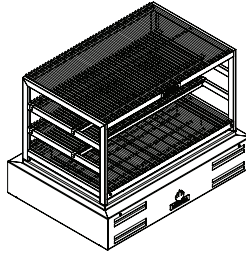

Approximate quantity of charcoal according to Robata Beast model:

Model	Initial charcoal load
RM 100	22 lb

7. Maintenance and safety standards

7.1. Daily cleaning

Do not use chemical products or water to clean the inside of the Mibrasa® Robata Beast.

Grills: clean using the grill brush before and after each use.

Ash extraction: use the ash shovel to remove the ash. Once the ashes have completely cooled down they can be used as fertilizer.

WARNING Do not dispose ashes in a flammable-container or heat-deformable container.

7.2. Special care

Exhaust hood: It is very important to keep the exhaust hood filters clean as well as the interior and ducts to avoid a build up of soot, fat and creosote¹, which could result in a possible fire.

Mibrasa® is not responsible for any damages occurred caused by wrongful use, when the installation instructions have not been followed or wrongful maintenance of the exhaust hood.

¹ Creosote – Formation and need for removal. When wood is burned slowly, it produces tar and other organic vapors that combine with expelled moisture to form creosote. The creosote vapors condense in a relatively cool oven flue and exhaust hood of a slow burning fire. As a result, creosote residue accumulates on the flue lining and exhaust hood.

When ignited, this creosote makes an extremely hot fire. The oven flue should be inspected at least twice a year to determine when creosote has occurred. When creosote has accumulated, it should be removed to reduce risk of fire.

8. General conditions

8.1. Warranty

- All Mibrasa® Robata Beasts have a 2-year warranty against any manufacturing defect.
- The customer will be responsible for the installation, fine-tuning and maintenance of the goods.
- The warranty is void of:
 - (I) damage caused by misuse or poor product installation,
 - (II) where the buyer or third party has started repairs, modifications or adjustments without the prior consent of Mibrasa®.
 - (III) those defects not immediately notified within the warranty period stated above,
 - (IV) those defects or damage due to negligence not attributable to Mibrasa®, or an accident, misuse, improper installation, mishandling or abnormal conditions of temperature, humidity or dirt.
 - (V) that have become damaged through no fault of Mibrasa®.

8.2. Returns

- All goods must be returned in the original condition.
- All returns must be notified in writing and must be confirmed by our sales department.
- All returns must reach Mibrasa® prepaid. Returned material must enclose the invoice and delivery note number.
- Returns of goods will only be accepted in its original packaging, unused and in re-sellable condition. Returned goods that are used, obsolete or worn out will not be considered under warranty and a credit note will not be issued.
- For all returned goods, there will be a 10% fee of the refund amount to cover depreciation, demerit and administrative tasks.

8.3. Property Reserve

- Mibrasa® retains title to the goods to the total amount of the price integrity.
- Mibrasa® reserves the right to change their products and prices without notice.



ROBATA BEAST MIBRASA®

MANUEL D'INSTRUCTIONS

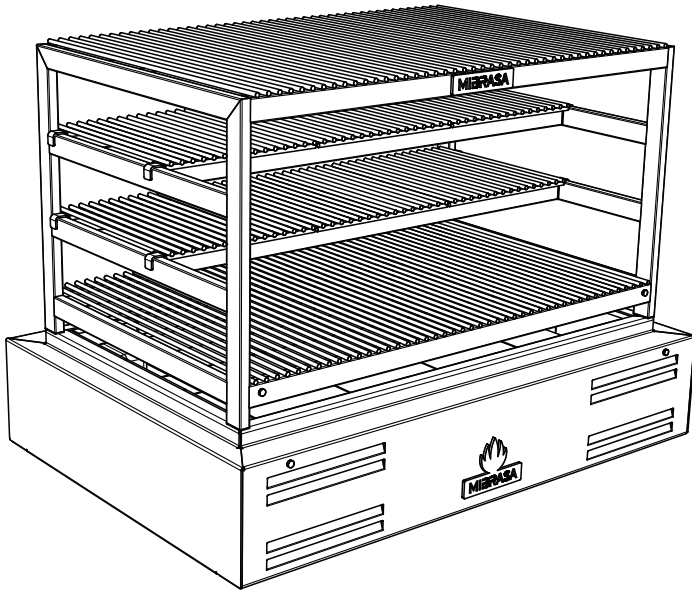

LIRE LES INSTRUCTIONS AVANT L'INSTALLATION ET L'UTILISATION DU ROBATA BEAST MIBRASA®. CONSERVER CES INSTRUCTIONS.

UNE DES PRINCIPALES CAUSES D'INCENDIE PROVOQUÉ PAR LE GRILL OUVERT SE DOIT AU NON-RESPECT DE LA MAINTENANCE DES ESPACES D'AIR REQUIS POUR TOUT MATÉRIAU COMBUSTIBLE. IL EST DE LA PLUS HAUTE IMPORTANCE QUE LE GRILL OUVERT SOIT INSTALLÉ CONFORMÉMENT AUX INSTRUCTIONS DE CE GUIDE.

The Craftsmen of Fire!

www.mibrasa.com

Mibrasa.

The Craftsmen of Fire!

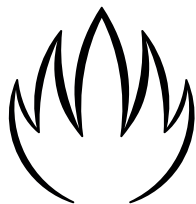

Nous vous invitons à expérimenter avec nos braises, à créer et cuisiner de manière à réveiller votre palais et faire parler votre cœur.

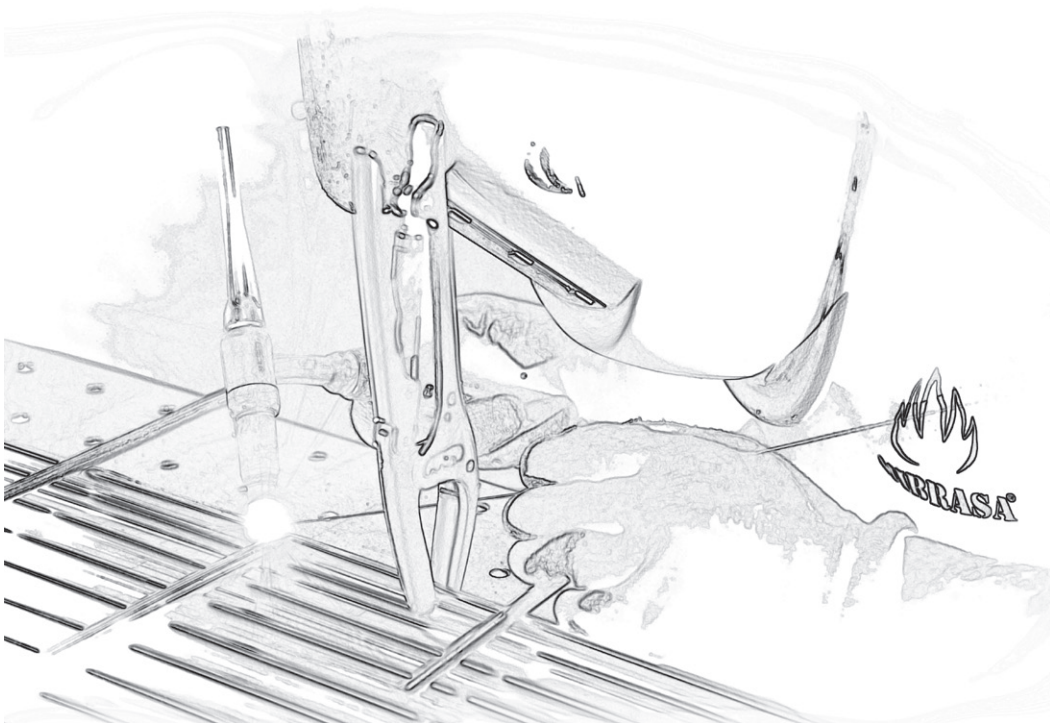

Index

1. Introduction	15
2. Dimensions du Robata Beast Mibrasa®	16
3. Normes de sécurité	18
4. Parties du Robata Beast Mibrasa®	5
5. Instructions d'installation	7
5.1. Indication de montage et normes de sécurité	
6. Mise en route	8
7. Maintenance et normes de sécurité	9
7.1 Nettoyage quotidien	
7.2 Soins particuliers	
8. Conditions générales	10
8.1 Garantie	
8.2 Retour	
8.3 Réserve de propriété	

9. Introduction

Le Robata Beast Mibrasa® est conceptualisé et conçu pour les chefs en besoin de production élevé et à la recherche de polyvalence.

Expérimentez sur les différents niveaux, avec différentes températures et positions des grilles pour appliquer des techniques de cuisson infinies en même temps.

Le Robata Beast Mibrasa® est fabriqué avec des aciers de dernière technologie et suivant des contrôles rigoureux de qualité, comme tous les équipements Mibrasa®.



Notre Robata Beast

Equipé de 4 niveaux fixes, offrant chacun des surfaces de cuisson étendues, adaptables et amovibles et permettant de cuisiner multiples ingrédients.

Exécutez des techniques de cuisson variées, cuisson directe, verticale, brochettes, à la broche, entre autres, il convient à tout type de gastronomie.

Garantisiez une efficacité thermique maximale à partir de la combustion de braises ou de bois, grâce à la base en briques réfractaires.

A lire attentivement avant d'utiliser le Robata Beast Mibrasa®.

Ne pas tenir compte des préventions de dangers, avertissements et précautions indiqués dans ce manuel, pourra occasionner de sérieuses lésions corporelles, un feu ou une explosion avec dommages matériels.

9.1. Normes de sécurité

- Utiliser uniquement du charbon végétal dans le Robata Beast Mibrasa®.
- Lors du premier allumage du Robata Beast Mibrasa®, attendre au minimum une heure avant la mise en service.
- Utiliser le Robata Beast Mibrasa® avec vigilance. Il ne doit jamais être laissé sans surveillance ou déplacé pendant son fonctionnement.
- **PRECAUTION** Ne pas surcharger le Robata Beast Mibrasa®. Consulter la table de charge du point 6.
- Les cendres doivent être déposées dans un récipient métallique. Ce récipient doit être placé dans un lieu loin des matériaux combustibles en attendant d'être vidé. Avant de vider le récipient, les cendres doivent refroidir complètement.
- Ne pas essayer d'éteindre les braises avec de l'eau.
- Ne pas nettoyer le Robata Beast Mibrasa® lorsqu'il est chaud ou en marche.
- Lorsque le Robata Beast Mibrasa® est chaud ou en marche, ne pas utiliser des produits chimiques pour nettoyer l'extérieur.

LES DANGERS

- Une mauvaise installation du Robata Beast Mibrasa® peut provoquer un incendie. Suivre les instructions d'installation recommandées.
- Éloigner les enfants et les animaux domestiques du Robata Beast Mibrasa®. Certaines parties accessibles du Robata Beast Mibrasa® peuvent être très chaudes.
- Ne pas utiliser d'alcool, d'essence ou autres liquides similaires pour allumer ou raviver les braises. Utiliser seulement les pastilles allume-feux Ecofire Mibrasa®.
- Si le Robata Beast Mibrasa® est installé à l'extérieur, ne pas le couvrir avec une housse ni aucun autre produit inflammable lorsqu'il est en fonctionnement ou chaud.
- Revoir les restrictions du point 5.1 concernant les distances minimales des matériaux combustibles.

3. Dimensions du Robata Beast Mibrasa

Dimensions en inches et [mm]

RM 100 BEAST

VUE FRONTAL

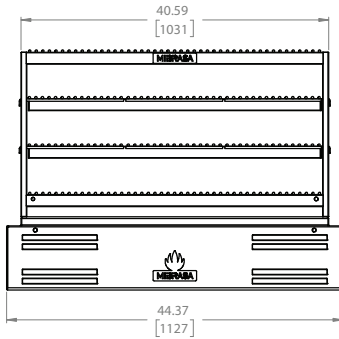

VUE LATÉRALE

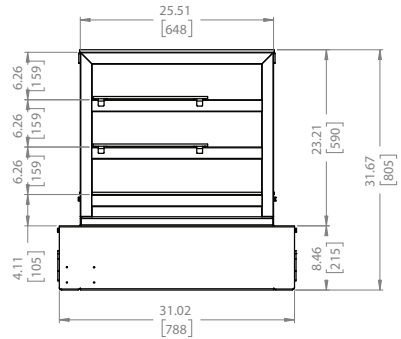

VUE SUPÉRIEURE

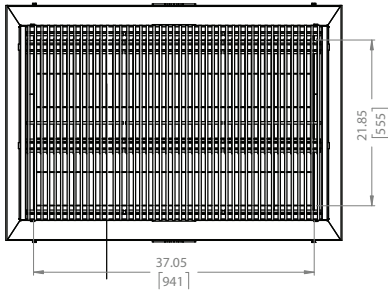

Dimensions de surface de cuisson de la grille supérieure et inférieure

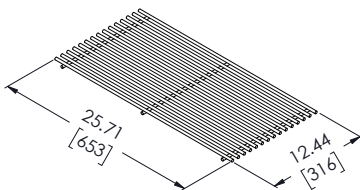

Dimensions de surface de cuisson de la grille intermédiaire

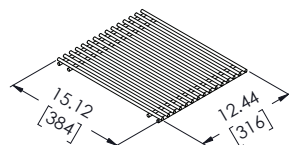

Le Robata Beast Mibrasa® est sujet à des modifications techniques et de design.

RM 100 BEAST avec meuble complet (MCGMB100)

Dimensions en inches et [mm]

VUE FRONTAL

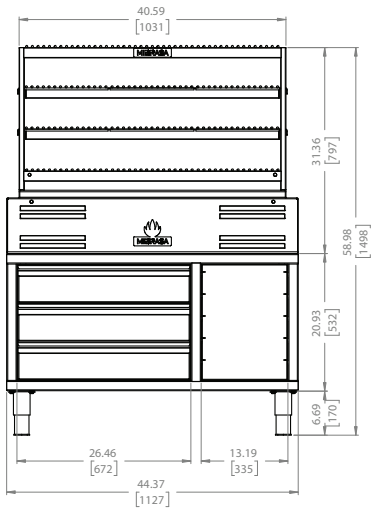

VUE LATÉRALE

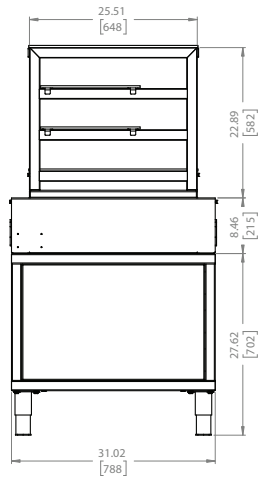

RM 100 BEAST avec meuble (MGMB100)

VUE FRONTAL

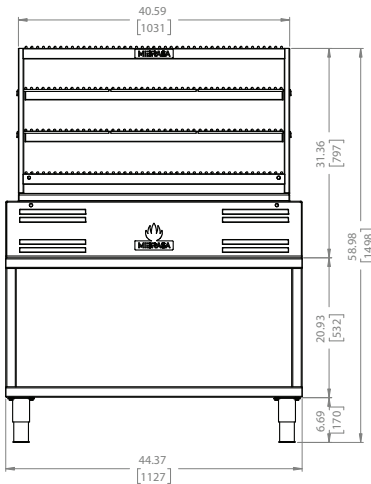

VUE LATÉRALE

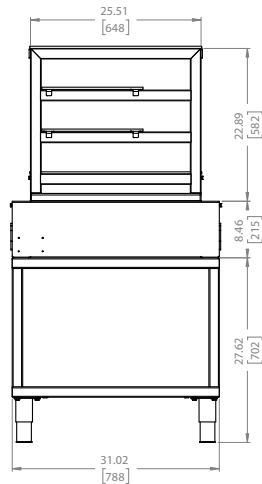

Le Robata Beast Mibrasa® est sujet à des modifications techniques et de design.

4. Parties du Robata Beast Mibrasa®

1. Structure

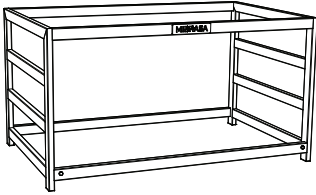

2. Foyer principal

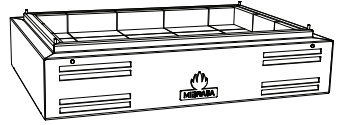

3. Barre de support



4. Briques refractaires



5. Grille supérieure et inférieure

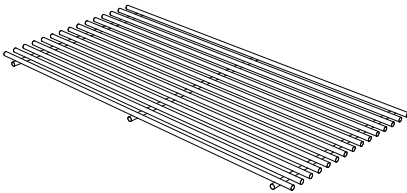

6. Grille intermédiaire

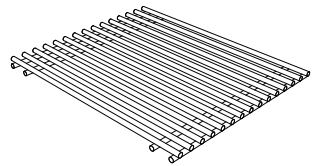

Accessoires inclus:

Grilles supérieures et inférieures (x6)

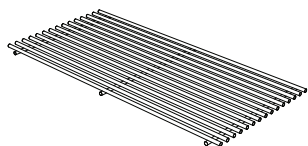

Grille intermédiaire (x6)

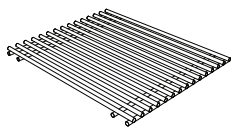

Pinces Mibrasa

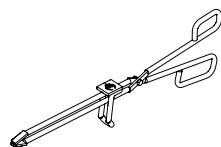

Pelle à cendre

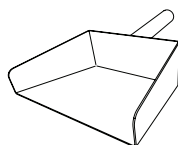

Tisonnier

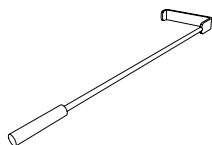

Brosse métallique

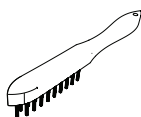

Tablettes allume-feu Ecofire Mibrasa®

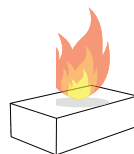

Accessoires optionnels:

Grille supérieure et inférieure

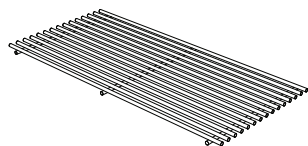

Grille intermédiaire

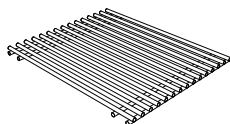

Meuble/meuble complet

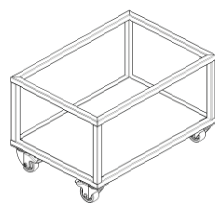

Couvercle

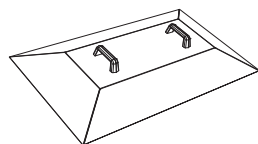

Broche

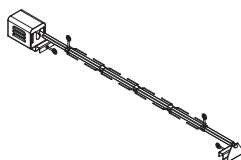

Ustensiles & Grillware



(consulter le catalogue sur www.mibrasa.com)

5. Instructions d'installation

1 Enlever les grills et les barres de support

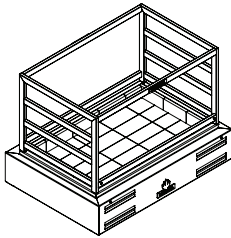

2 Enlever la structure

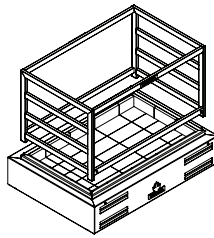

3 Placez le corps principal sur la table/meuble

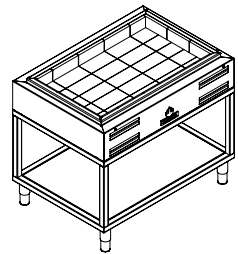

4 Repositionner la structure

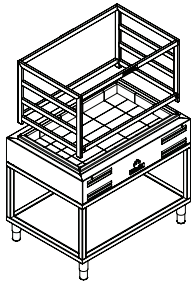

5 Repositionner la grille et les barres de support

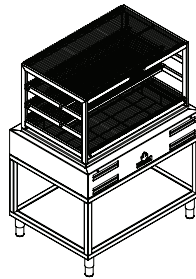

6 Prêt à être utilisé

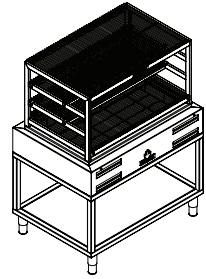

5.1 Indications de montage et normes de sécurité

L'installateur doit contacter le responsable de la commission de sécurité incendie de l'établissement pour déterminer s'il existe des restrictions ou besoin d'inspection avant l'installation du Robata Beast Mibrasa®.

- Maintenir éloignées toutes substances combustibles à une distance de 300 mm de la partie avant, arrière ou latérale du Grill Ouvert.
- Espace libre requis aux éléments construits/appareils électrodomestiques: à 100 mm des murs latéraux et murs arrières.

Espace du travail du chef et hauteur d'installation recommandée:

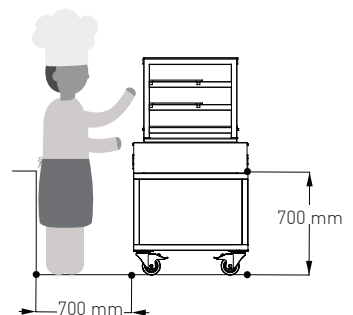

Recommandations de ventilation:

Modèle	Débit (m ³ /h)	Mesures hotte centrale (Largeur x Profondeur en mm)	Hauteur min. entre sol et hotte (mm)
RM 100	4100	1500 x 1300	2000

6. Mise en route

1 Enlever les grilles et charger le charbon

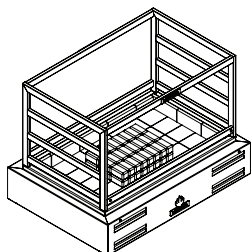

2 Placer et allumer les tablettes allume-feu

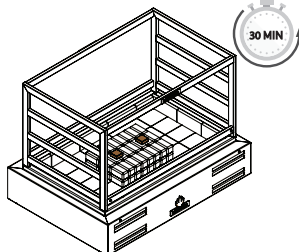

3 Étaler les braises

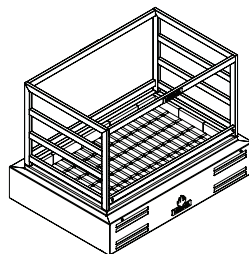

Allumez toujours le charbon à l'intérieur de la base réfractaire.

5 Remettre en place les grilles

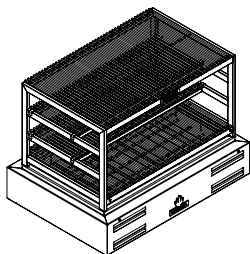

6 Prêt pour la cuisson

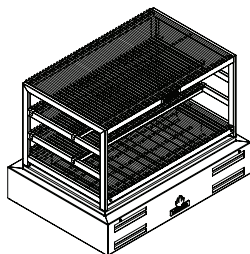

Quantité approximative de charbon selon le modèle Robata Beast Mibrasa®

Modèle	Charge initiale de charbon
RM 100	10 Kg

7. Normes de maintenance et de sécurité

7.1. Nettoyage quotidien

Ne pas utiliser de produits chimiques ou de l'eau pour nettoyer l'intérieur du Robata Beast Mibrasa®.

Grilles: Nettoyer à l'aide d'une brosse métallique avant et après chaque service.

Extraction des cendres: Retirer les cendres à l'aide d'une pelle métallique. Une fois refroidies, elles peuvent être utilisées comme engrais.

ATTENTION! N'oubliez pas de vider les cendres de charbon dans un récipient non inflammable ou déformable. Placer les dans un récipient métallique.

7.2. Soins particuliers

Hotte d'extraction et conduits: Il est très important de conserver les filtres de la hotte d'extraction propres et de nettoyer l'intérieur du plénum et des conduits pour éviter une accumulation de suie et de graisse, ce qui pourrait conduire à la propagation d'un éventuel incendie.

Nettoyage hebdomadaire et entretien annuel de la hotte, du caisson de ventilation et des conduits selon les recommandations du fabricant de la hotte.

Mibrasa® ne sera en aucun cas responsable de possibles dommages qui pourraient être causés par une mauvaise utilisation du Robata Beast Mibrasa® et des installations qui ne correspondraient pas aux recommandations données.

8. Conditions générales

8.1. Garantie

- Tous les Robata Beast Mibrasa® sont garantis 2 ans contre tout défaut de fabrication.
- Le client est responsable de l'installation, la mise en service et la maintenance du produit.
- La garantie est annulée en cas de:
 - (I) dommages causés par un mauvais usage ou mauvaise installation du produit,
 - (II) réparations, modifications ou réglages effectués par l'acheteur ou tierce sans l'autorisation préalable de Mibrasa®,
 - (III) défauts ou dommages non communiqués dans la période de garantie ci-dessus indiquée,
 - (IV) dommages dus à une négligence non attribuable à Mibrasa®, accident, mauvaise utilisation, installation inappropriée, mauvaise manipulation ou conditions anormales de température, humidité, salissure, corrosion ou toute autre cause extérieure à Mibrasa®.

8.2. Retours

- Le matériel retourné doit être en parfaite condition de conservation.
- Tous les retours doivent être notifiés par écrit et doivent être confirmés par notre service commercial.
- Tous les retours doivent être renvoyés à Mibrasa® aux frais du client et doivent être accompagnés de la facture et du numéro du bon de livraison.
- Les retours seront acceptés à condition que le four soit dans son emballage d'origine, non utilisé et à l'état neuf. Si le four est utilisé, obsolète ou abîmé, il sera détruit sans aucun remboursement effectué.
- Pour tout retour, une décote de 10 % sera appliquée pour couvrir les frais de gestion.

8.3. Réserve de propriété

- Mibrasa® conserve la propriété des biens vendus jusqu'au paiement effectif de l'intégralité de leur prix.
- Mibrasa® se réserve le droit de modifier sans préavis ses produits et ses prix.

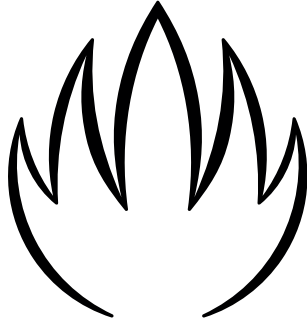

MIBRASA®

The Craftsmen of Fire!

8950 SW 74th Ct., Suite 1406
Miami, Florida 33156
(408) 348-7607
www.mibrasa.com
usa@mibrasa.com

Version 11.22