



---

# MIBRASA® PARRILLA

## USER MANUAL

---

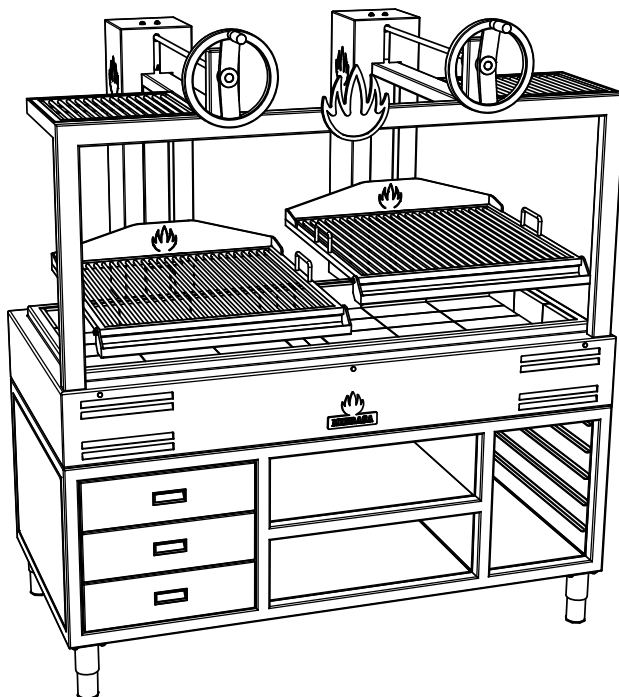

READ ALL INSTRUCTIONS BEFORE INSTALLING AND USING THE APPLIANCE.  
SAVE THESE INSTRUCTIONS.

A MAJOR CAUSE OF PARRILLA-RELATED FIRES IS FAILURE TO MAINTAIN RE-  
QUIRED CLEARANCES (AIR SPACES) TO COMBUSTIBLE MATERIALS. IT IS OF  
UTMOST IMPORTANCE THAT THIS PARRILLA BE INSTALLED ONLY IN ACCOR-  
DANCE WITH THESE INSTRUCTIONS.

*The Craftsmen of Fire!*

[www.mibrasa.com](http://www.mibrasa.com)

PLEASE READ THIS ENTIRE MANUAL YOU INSTALL THE OVEN. FAILURE TO FOLLOW INSTRUCTIONS MAY RESULT IN PROPERTY DAMAGE, BODILY INJURY, OR EVEN DEATH. SAVE THESE INSTRUCTIONS

## Contents

1. Introduction	
2. Mibrasa® Parrilla dimensions	1
3. Parts of the Mibrasa® Parrilla	3
4. Installation instructions	5
4.1. Installation guidelines and safety standards	
5. Lighting up	6
6. Parrilla operation	6
7. Maintenance and safety standard	7
7.1. Daily and weekly cleaning	
7.2. Maintenance	
7.3. Special care	
8.3. Safety standards	
8. General conditions	9
8.1. Warranty	
8.2. Returns	
8.3. Property Reserve	

# 1. Introduction

---

Precision and strength defines the new Mibrasa® Parrilla. Thanks to the carefully engineered design with elevation system and positional brake, the Mibrasa® Parrilla effortlessly regulates the height of the grill from the heat of embers with maximum safety and minimum maintenance.

The Mibrasa® Parrilla lets us sear, cook and rest our ingredients, achieving the optimal result every time.

The Mibrasa® Parrilla is manufactured with steels of the latest technology following the most rigorous quality controls. Like all Mibrasa® units, they comply to the strict standards & regulations set by internationally recognized certifications of quality.



## Parrilla by Mibrasa®

Ergonomic design, maximum quality and security.

Our Parrilla has an elevating system designed and patented by Mibrasa® that enables height adjustments between the grill and hot coals to provide the chef with total control allowing them to cook with more efficiency.

With a sloping grill, the grease runs down the weld-free grill bars to prevent grease build-up. Grease drips down to the collector with an easy to remove mechanism ready to clean.

The base is lined with refractory bricks to ensure maximum heat efficiency and resistance to pure fire. The built-in cooling system in the outer case guarantees maximum safety.

Built using quality steels providing strength and durability; ergonomically designed for practicality and ease of use, each feature plays a crucial part in delivering the ultimate grilling machine for every chef.

Parrilla grilling lends itself to an array of foods from meat, fish, seafood and vegetables, imparting light smoky aromas and flavours we seek in grill cooking. Any other use instead of cooking food is not allowed

## 2. Mibrasa® Parrilla dimensions

Dimensions in inches

### SIDE VIEW OF ALL MODELS

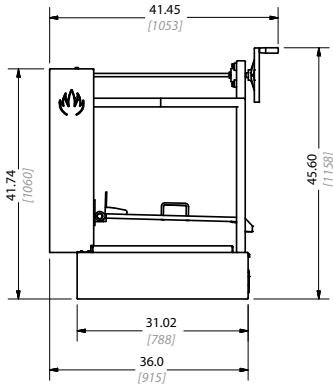

### GMB 100 FRONT VIEW

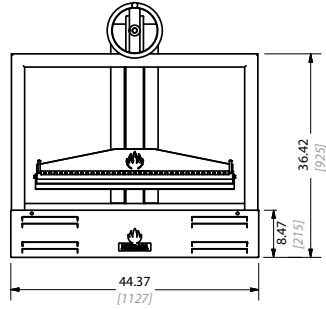

### GMB 130 FRONT VIEW

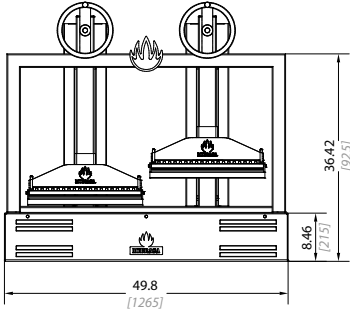

### GMB 160 FRONT VIEW

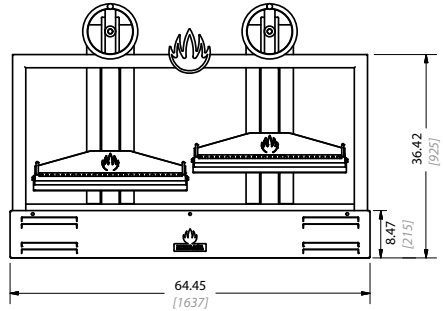

### GMB 200 FRONT VIEW

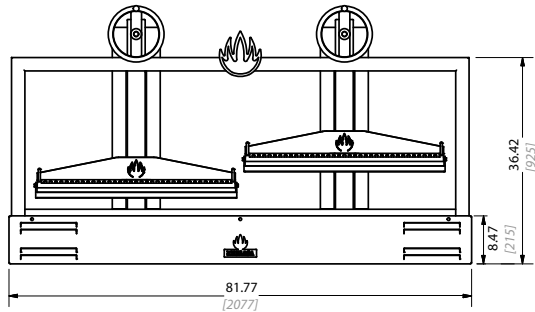

### 3. Mibrasa® Parrilla dimensions

Dimensions in inches

SIDE VIEW OF ALL MODELS

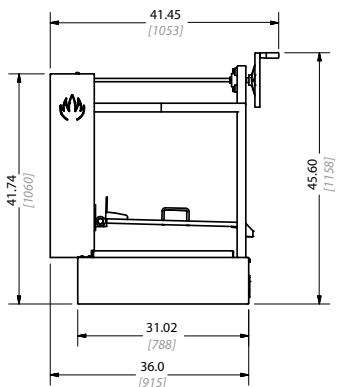

GMB 200-3GR FRONT VIEW

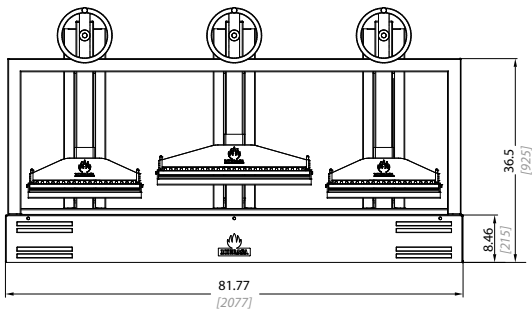

GMB 252-3GR FRONT VIEW

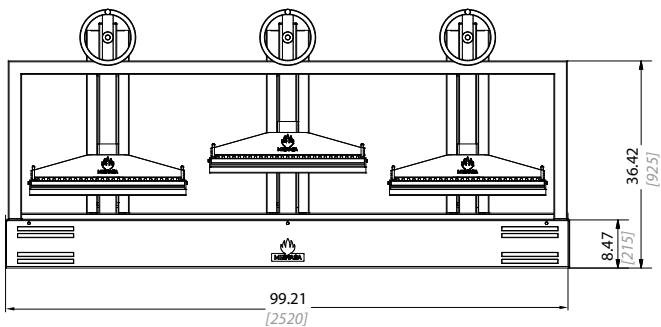

### 3. Parts of the Mibrasa® Parrilla

#### 1. Structure

1.a Guide column ▶ 1.b Drive shaft

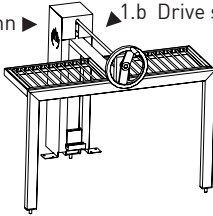

#### 2. Burning pit base

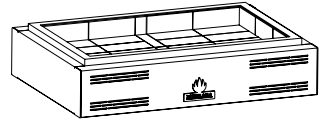

#### 3. Rod grill

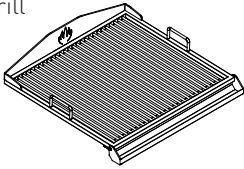

#### 4. Elevating wheel



#### 5. Heating rack grills

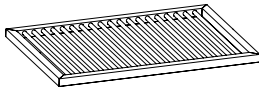

#### 6. Refractory bricks



#### 7. Grease collector



#### Grill dimensions:

GMB 100 (1)  
GMB 200 (2)

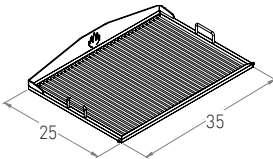

GMB 130 (2)  
GMB 200-3GR (2)

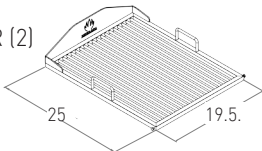

GMB 160 (2)  
GMB 200-3GR (1)  
GMB 252-3GR (3)

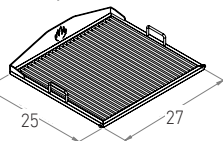

#### Heating rack grill dimensions:

GMB 100  
GMB 200

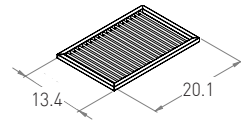

GMB 130  
GMB 200-3GR

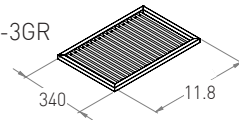

GMB 160  
GMB 252-3GR

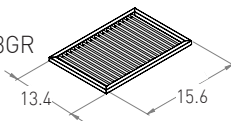

**Included accessories:**

Rod grill

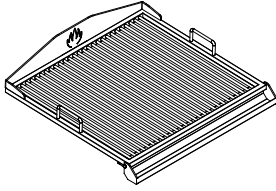

Heating rack grills (x2)

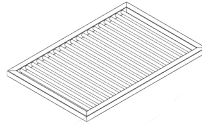

Mibrasa tongs

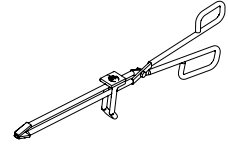

Ash shovel

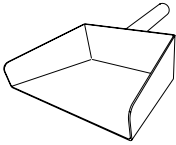

Ember poker

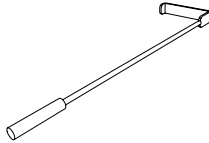

Grill brush

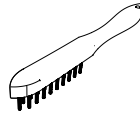

Mibrasa Ecofire firelighters

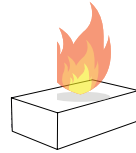

GMB 160 and 200 include 2 rod grills, 2 Mibrasa tongs and 2 grill brushes.

**Optional accessories:**

V-channel grill

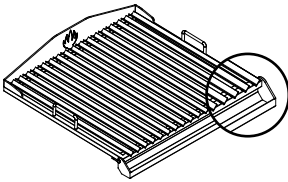

Extra rod grill

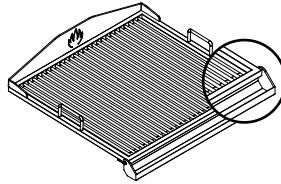

Standard stand/  
Complete stand

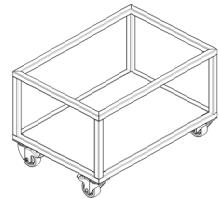

End of service lid

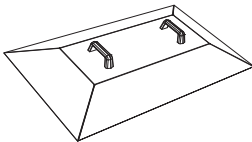

Cooking support rack

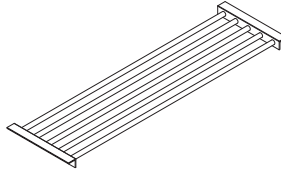

Swivel hook



Thermic protective  
structure

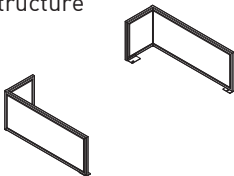

Kitchenware



[Consult catalog at  
[www.mibrasa.com](http://www.mibrasa.com)]

## 4. Installation instructions

1 Remove the grease collector and the grill

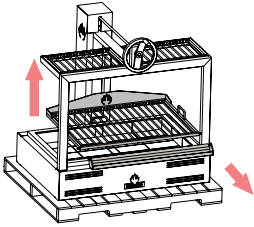

2 Dismantle the structure

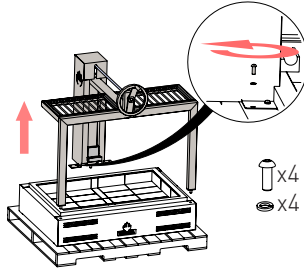

3 Place the main body on top of the stand.

\*A certified "NSF" silicone shall be used to seal the main body to the countertop.

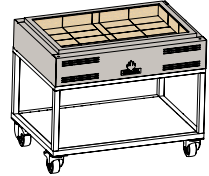

4 Replace the structure

5 Reinsert the grill into place

6 Ready to work

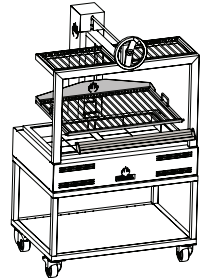
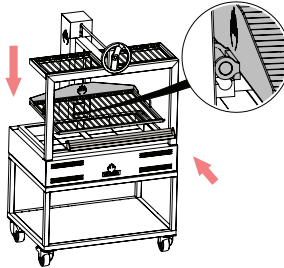
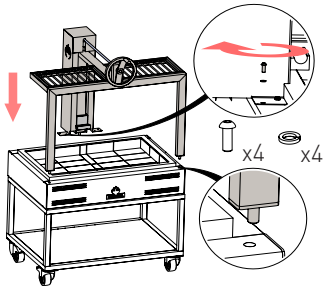

### 4.1 Installation and safety standards

- Clearances to construction:  
Unit to backwalls: 7 in (180 mm)  
Unit to sidewalls: 28 in (720 mm)
- Workspace for the chef and recommended height of the worktop (see image).

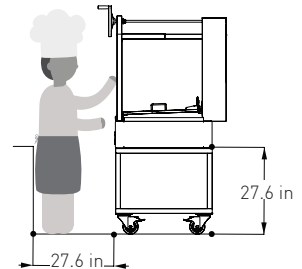

### Ventilation recommendations

Model	Flow rate (gal/s)	Hood dimensions (Width x depth in inches)	Minimum height of hood from floor (in)
GMB 100	300	59.05 x 51.18	78.74
GMB 130	315	70.86 x 51.18	
GMB 160	337	78.74 x 51.18	
GMB 200/200-3GR	374	98.43 x 51.18	
GMB 252-3GR	410	98.43 x 51.18	

Installation of the exhaust hood with the Standard for Ventilation Control and Fire Protection of Commercial cooking operations, NFPA 96.



## 5. Lighting up

1 Remove the grease collector and the grill

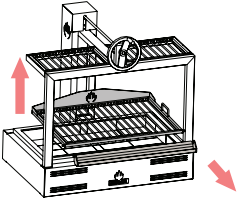

2 Load the charcoal

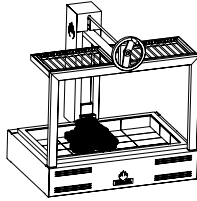

3 Place and light the Ecofire firelighters

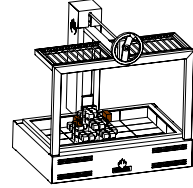

Always light the charcoal inside the refractory base.

4 Spread the embers

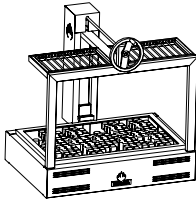

5 Reinsert the grill and the grease collector

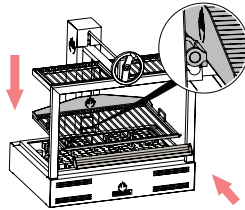

6 Ready to cook

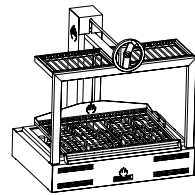

Approximate quantity of charcoal according to the Parrilla model:

Model	Initial charcoal load
GMB 100	22 lb
GMB 130	26 lb
GMB 160	33 lb
GMB 200/200-3GR	44 lb
GMB 252-3GR	55 lb

## 6. Parrilla operation

Grease collector:

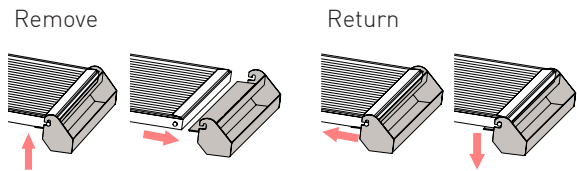

Adjusting the grill height:

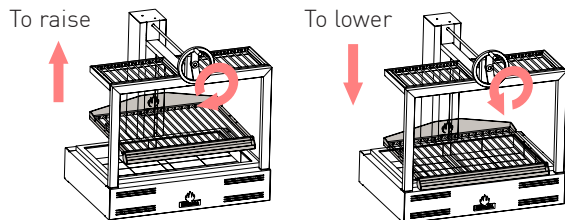

## 7. Maintenance and safety standards

---

### 7.1. Daily cleaning

Do not use chemical products or water to clean the inside of the Parrilla.

**Lifting system:** Once cold, clean the entire surface of the guide column and the drive shaft with degreaser.

**Grills:** Clean using the grill brush before and after each use.

**Ash extraction:** Use the ash shovel to remove the ash. Once the ashes have completely cooled down they can be disposed of or used as fertilizer.

**WARNING** Do not dispose the ashes in a flammable-container or heat-deformable container.

### Weekly cleaning

If dirt is detected inside the lifting system that cannot be cleaned externally with the daily cleaning of the guide column, when it is cold, proceed to remove the protection casing by unscrewing the four lower and two upper screws. Once clean, proceed in reverse to mount the protection.

### 7.2. Maintenance

Every six months, remove the protection casing from the gears and clean the gears, pulleys and the lift system with degreaser. Once this cleaning has been carried out, grease the entire system with special grease for high temperatures (minimum use temperature 300°).

It is recommended to review the status of the steel cable of the elevation system every two years.

### 7.3. Special care

**Exhaust hood:** It is very important to keep the exhaust hood filters clean as well as the interior and ducts to avoid a build up of soot, fat and creosote<sup>1</sup>, which could result in a possible fire.

Mibrasa® is not responsible for any damages occurred caused by wrongful use, when the installation instructions have not been followed or wrongful maintenance of the exhaust hood.

<sup>1</sup> Creosote – Formation and need for removal. When wood is burned slowly, it produces tar and other organic vapors that combine with expelled moisture to form creosote. The creosote vapors condense in a relatively cool oven flue and exhaust hood of a slow burning fire. As a result, creosote residue accumulates on the flue lining and exhaust hood. When ignited, this creosote makes an extremely hot fire. The oven flue should be inspected at least twice a year to determine when creosote buildup has occurred. When creosote has accumulated, it should be removed to reduce risk of fire.

Please read this entire manual before you install the Mibrasa® Parrilla.  
Failure to follow instructions may result in property damage, bodily injury, or even death.

#### 7.4. Safety standards

##### WARNINGS

- Do not pack required air spaces with insulation or other materials.
- Only use charcoal in the Mibrasa® Parrilla.
- The first time the Parrilla is used do not cook food for at least one hour after lighting.
- Proceed with reasonable care when operating a Mibrasa® Parrilla. Never leave it unattended when lit.
- **CAUTION** Do not overload/fire. Consult the loading table of point 5 when flames spill out of the oven, you are over-firing.
- Disposal of ashes – Ashes should be placed in a metal container with a tight-fitting lid. The closed container of ashes should be placed on a non-combustible floor or on the ground, well away from all combustible materials, pending final disposal. When the ashes are disposed by burial in soil or otherwise locally dispersed, they should be retained in the closed container until all cinders have thoroughly cooled.
- Do not attempt to pour water over the hot coals.
- Do not clean the Parrilla when it is in operation or still hot.
- Do not use chemical products to clean the exterior of the Parrilla when in use or hot.

##### DANGERS

- If the Parrilla is not properly installed, a fire may result. To reduce the risk of fire, follow the installation instructions.
- Keep children and pets away from the oven and flammable products. Accessible parts of the Parrilla may be very hot.
- Never use gasoline, gasoline-type lantern fuel, kerosene, charcoal lighter fluid, or similar liquids to start or 'freshen up' a fire in this oven. Keep such liquids well away from the oven when in use.
- In the case of installing the Parrilla in an outdoor setting, do not cover it with any type of protective cover or inflammable material when it is in operation or hot.
- Read the restrictions in point 4.1 on minimum distances from combustible materials.

## 8. General conditions

---

### 8.1. Warranty

- All Mibrasa® Parrilla grills have a 2-year warranty against any manufacturing defect.
- The customer will be responsible for the installation, fine-tuning and maintenance of the goods.
- The warranty is void of:
  - (I) damage caused by misuse or poor product installation,
  - (II) where the buyer or third party has started repairs, modifications or adjustments without the prior consent of Mibrasa®,
  - (III) those defects not immediately notified within the warranty period stated above,
  - (IV) those defects or damage due to negligence not attributable to Mibrasa®, or an accident, misuse, improper installation, mishandling or abnormal conditions of temperature, humidity or dirt,
  - (VI) that have become damaged through no fault of Mibrasa®.

### 8.2. Returns

- All goods must be returned in the original condition.
- All returns must be notified in writing, and must be confirmed by our sales department.
- All returns must reach Mibrasa® prepaid. Returned material must enclose the invoice and delivery note number.
- Returns of goods will only be accepted in its original packaging, unused and in re-sellable condition. Returned goods that are used, obsolete or worn out will not be considered under warranty and a credit note will not be issued.
- For all returned goods, there will be a 10% fee of the refund amount to cover depreciation, demerit and administrative tasks.

### 8.3. Property Reserve

- Mibrasa® retains title to the goods to the total amount of the price integrity.
- Mibrasa® reserves the right to change their products and prices without notice.







---

# GRILL OUVERT MIBRASA®

## MANUEL D'INSTRUCTIONS

---

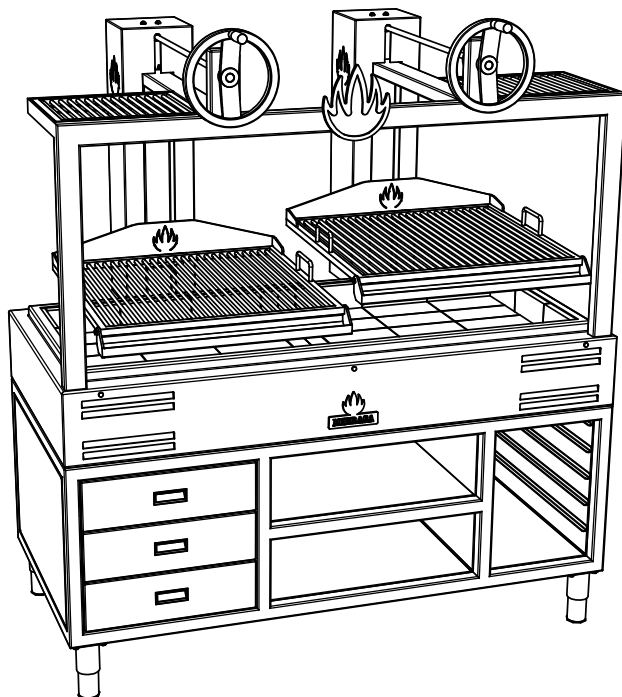

UNE DES PRINCIPALES CAUSES D'INCENDIE PROVOQUÉ PAR LE GRILL OUVERT SE DOIT AU NON-RESPECT DE LA MAINTENANCE DES ESPACES D'AIR REQUIS POUR TOUT MATÉRIAU COMBUSTIBLE. IL EST DE LA PLUS HAUTE IMPORTANCE QUE LE GRILL OUVERT SOIT INSTALLÉ CONFORMÉMENT AUX INSTRUCTIONS DE CE GUIDE.

*The Craftsmen of Fire!*

[www.mibrasa.com](http://www.mibrasa.com)

## Index

1. Introduction	
2. Dimensions du Grill Ouvert Mibrasa®	1
3. Parties du Robotayaki	3
4. Instructions d'installation	5
4.1. Indication de montage et normes de sécurité	
5. Mise en route	6
6. Fonctionnement	6
7. Maintenance et normes de sécurité	7
7.1. Nettoyage quotidien et hebdomadaire	
7.2. Maintenance	
7.3. Soins particuliers	
8.3. Normes de sécurité	
8. Conditions générales	9
8.1. Garantie	
8.2. Retour	
8.3. Réserve de propriété	



# 1. Introduction

---

Précision et solidité définissent le Grill Ouvert Mibrasa®. Son design soigné est muni d'un système d'élévation sans effort avec frein automatique à fin de positionner la grille à sa guise, ce qui permet un réglage optimal vis à vis des braises avec la plus grande sécurité et un minimum d'entretien.

Le Grill Ouvert Mibrasa® permet de marquer, braiser et reposer le produit en obtenant à chaque fois le résultat de cuisson souhaité.

Le Grill Ouvert Mibrasa® est fabriqué avec des aciers de dernière technologie et suivant des contrôles rigoureux de qualité, comme tous les équipements Mibrasa®.



## Nos Grills Ouverts

Design ergonomique. Qualité et sécurité maximales.

Le Grill Ouvert Mibrasa® incorpore un système d'élévation dessiné et breveté par Mibrasa® qui permet d'adapter à souhait la distance entre la grille et la braise. Le cuisinier peut ainsi contrôler la cuisson des aliments avec beaucoup plus d'efficacité.

La surface de la grille est légèrement inclinée pour que la graisse s'écoule jusqu'au collecteur amovible pour faciliter le nettoyage.

Sa base réfractaire assure une efficacité énergétique totale et le système d'isolation de châssis extérieur garantit la plus grande sécurité pour le chef.

La qualité des matériaux, l'ergonomie et le design apportent au chef une durabilité, un confort et de parfaites cuissons.

## 2. Dimensions du Grill Ouvert Mibrasa®

Dimensions en mm

VUE LATÉRALE POUR CHAQUE MODÈLE

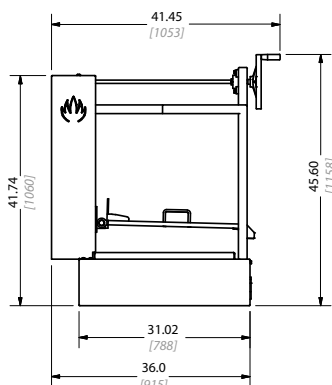

GMB 100 VUE FRONTALE

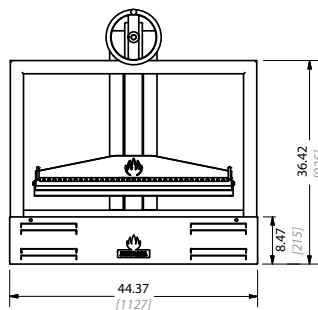

GMB 130 VUE FRONTALE

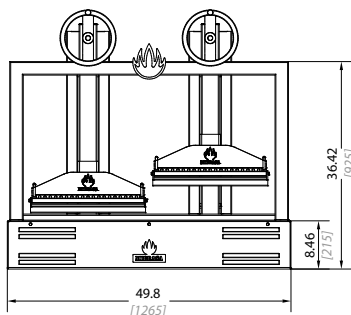

GMB 160 VUE FRONTALE

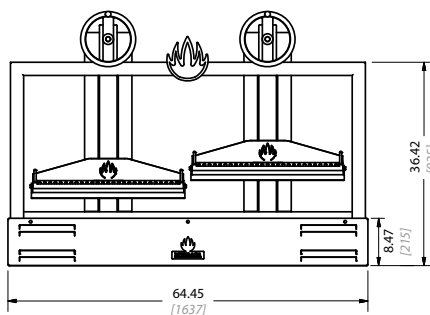

GMB 200 VUE FRONTALE

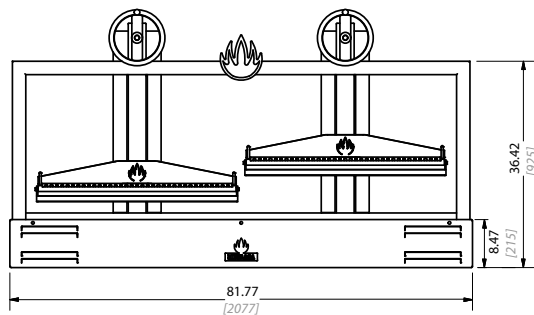

## 2. Dimensions du Grill Ouvert Mibrasa®

Dimensions en mm

VUE LATÉRALE POUR CHAQUE MODÈLE

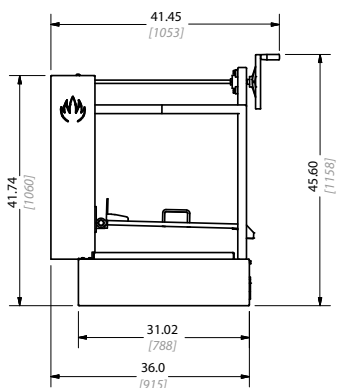

GMB 200-3GR FRONT VIEW

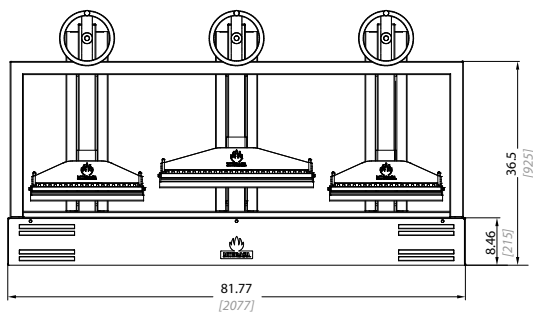

GMB 252-3GR FRONT VIEW

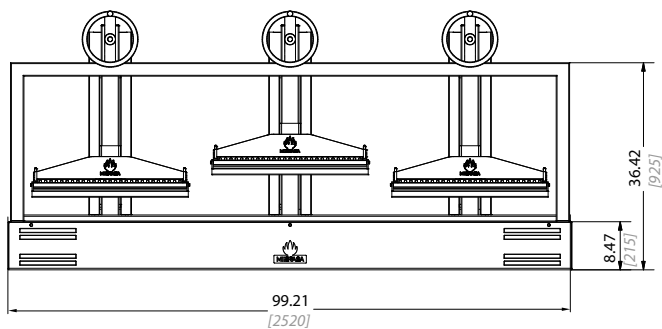

### 3. Parties du Grill Ouvert Mibrasa®

#### 1. Structure

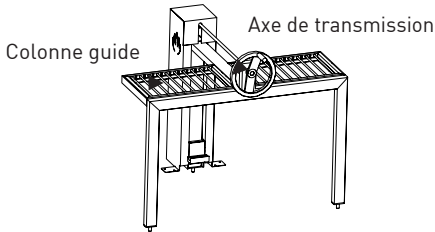

#### 2. Foyer principal

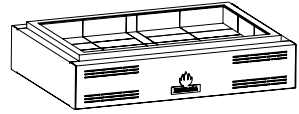

#### 3. Grille ronde

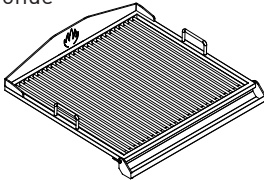

#### 4. Volant d'élévation



#### 5. Grilles de support de plateaux

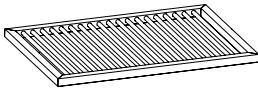

#### 6. Briques réfractaires

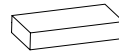

#### 7. Collecteur de graisse



#### Dimensions des grilles:

GMB 100 (1)  
GMB 200 (2)

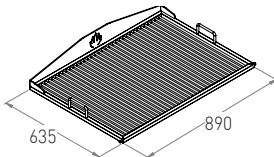

GMB 130 (2)  
GMB 200-3GR (2)

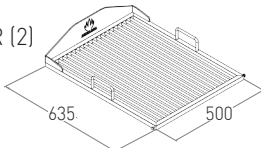

GMB 160 (2)  
GMB 200-3GR (1)  
GMB 252-3GR (3)

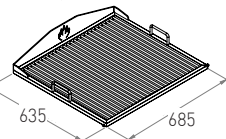

#### Dimensions des grilles de support de plateaux:

GMB 100  
GMB 200

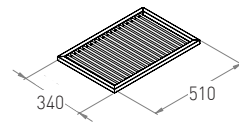

GMB 130  
GMB 200-3GR

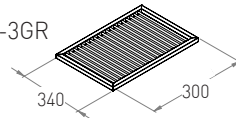

GMB 160  
GMB 252-3GR

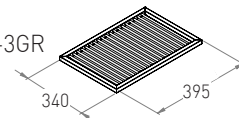

Dimensions en mm

Le Grill Ouvert Mibrasa® est sujet à des modifications techniques et de design.

## Accessoires inclus:

Grille ronde

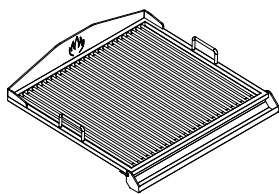

Grilles de support de plateaux (x2)

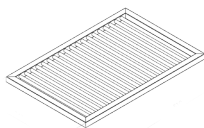

Pinces Mibrasa

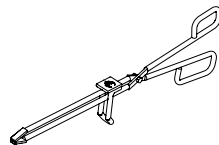

Pelle à cendre

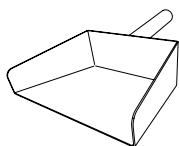

Tisonnier

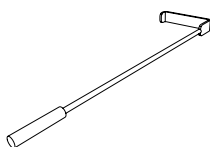

Brosse métallique

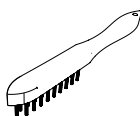

Tablettes allume-feu Ecofire Mibrasa®

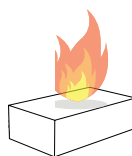

Les GMB 160 et 200 incluent 2 grilles rondes, 2 pinces Mibrasa et 2 brosses métalliques.

## Accessoires optionnels:

Grille en V

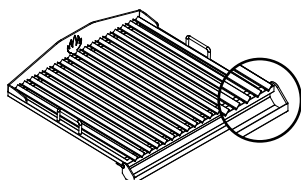

Grille ronde

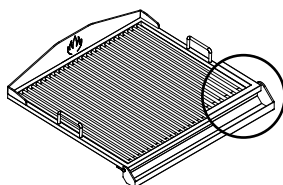

Meuble/Meuble complet

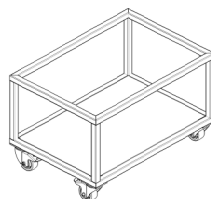

Couvercle

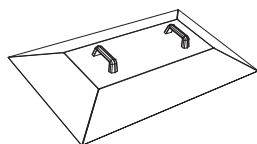

Support de cuisson

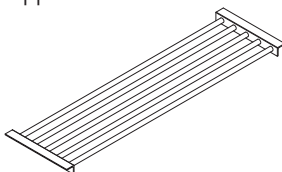

Crochet rotatif



Structure protectrice thermique

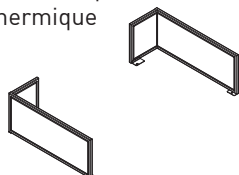

Ustensiles



[consulter le catalogue sur [www.mibrasa.com](http://www.mibrasa.com)]

## 4. Instructions d'installation

1 Enlever la grille et le collecteur de graisse

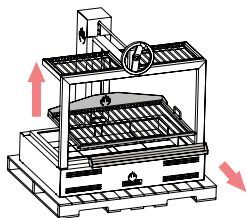

2 Enlever la structure

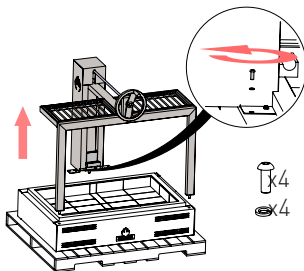

3 Placez le corps principal sur la table

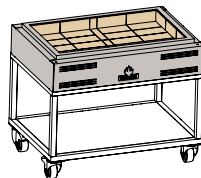

4 Repositionner la structure

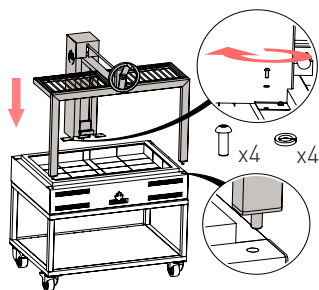

5 Repositionner la grille

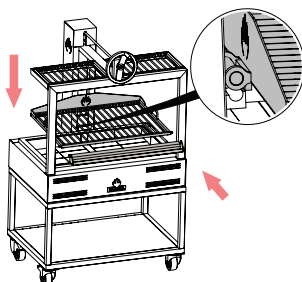

6 Prêt à être utilisé

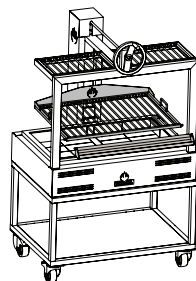

### 4.1 Indications de montage et normes de sécurité

- Maintenir éloignées toutes substances combustibles à une distance de 300 mm de la partie avant, arrière ou latérale du Grill Ouvert.
- Espace libre requis aux éléments construits/appareils électrodomestiques: a 100 mm des murs latéraux et murs arrières.
- Espace du travail du chef et hauteur d'installation recommandée:

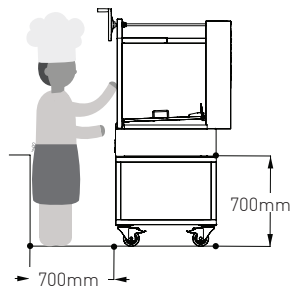

Recommandations de ventilation:

Modèle	Débit (m <sup>3</sup> /h)	Mesures hotte centrale (Largeur x Profondeur en mm)	Hauteur min. entre sol et hotte (mm)
GMB 100	4100	1500 x 1300	2000
GMB 130	4300	1800 x 1300	2000
GMB 160	4600	2000 x 1300	2000
GMB 200 / 200-3GR	5100	2500 x 1300	2000
GMB 252-3GR	5600	3000 x 1300	2000

## 5. Mise en route

- 1 Enlever le collecteur de graisse et la grille

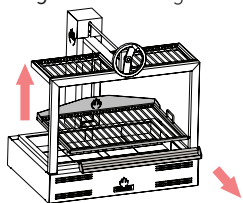

- 2 Charger le charbon

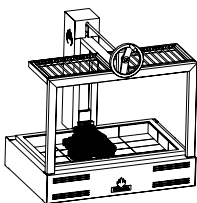

- 3 Placer et allumer les tablettes allume-feu

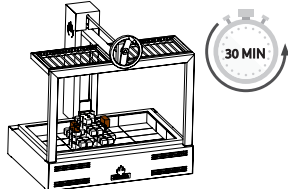

Allumez toujours le charbon à l'intérieur de la base réfractaire.

- 4 Étaler les braises

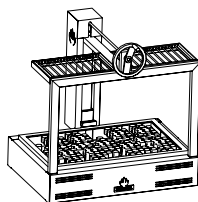

- 5 Remettre en place la grille et le collecteur de graisse

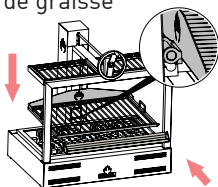

- 6 Prêt pour la cuisson

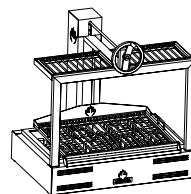

Quantité approximative de charbon selon le modèle:

Modèle	Charge initiale de charbon
GMB 100	10 Kg
GMB 130	12 Kg
GMB 160	15 Kg
GMB 200-3GR	20 Kg
GMB 252-3GR	25 Kg

## 6. Fonctionnement

Collecteur de graisse:

Retirer

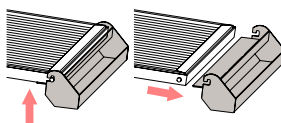

Remettre en position

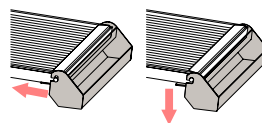

Régler la hauteur de la grille:

Pour monter

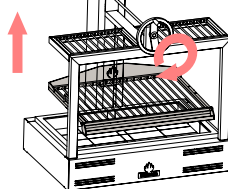

Pour baisser

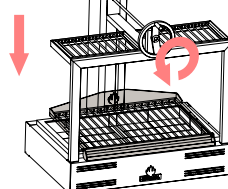

## 7. Normes de maintenance et de sécurité

---

### 7.1. Nettoyage quotidien

Ne pas utiliser de produits chimiques ou de l'eau pour nettoyer l'intérieur du Grill Ouvert.

**Système d'élévation:** une fois refroidie, laver toute la surface de la colonne guide et de l'axe de transmission avec un dégraissant.

**Grilles:** Nettoyer à l'aide d'une brosse métallique avant et après chaque service.

**Extraction des cendres:** Retirer les cendres à l'aide d'une pelle métallique. Une fois refroidies, elles peuvent être utilisées comme engrais.

**ATTENTION!** N'oubliez pas de vider les cendres de charbon dans un récipient non inflammable ou déformable. Placer les dans un récipient métallique.

### Nettoyage hebdomadaire

Si le système de levage est sale et ne peut pas être nettoyé de l'extérieur avec un nettoyage quotidien, lorsque le parrilla est froid, retirez le boîtier de protection en dévissant les quatre vis inférieures et les deux supérieures. Une fois le système propre, procédez à l'assemblage du boîtier et revissez-le dans la même position initiale.

### 7.2. Maintenance

Tous les six mois, enlever la carcasse de protection des engrenages et nettoyer les engrenages, les poulies et le chariot élévateur avec un dégraissant. Une fois ce nettoyage effectué, engraisser tout le système avec une graisse spéciale pour haute température (température minimum d'utilisation: 300°).

Il est recommandé de vérifier tous les deux ans l'état du câble en acier du système d'élévation.

### 7.3. Soins particuliers

**Hotte d'extraction et conduits:** Il est très important de conserver les filtres de la hotte d'extraction propres et de nettoyer l'intérieur du plénum et des conduits pour éviter une accumulation de suie et de graisse, ce qui pourrait conduire à la propagation d'un éventuel incendie.

Nettoyage hebdomadaire et entretien annuel de la hotte, du caisson de ventilation et des conduits selon les recommandations du fabricant de la hotte.

Mibrasa® ne sera en aucun cas responsable de possibles dommages qui pourraient être causés par une mauvaise utilisation du Grill Ouvert et des installations qui ne correspondraient pas aux recommandations données.



A lire attentivement avant d'utiliser le Grill Ouvert Mibrasa®.

Ne pas tenir compte des préventions de dangers, avertissements et précautions indiqués dans ce manuel, pourra occasionner de sérieuses lésions corporelles, un feu ou une explosion avec dommages matériels.

#### 7.4. Normes de sécurité

- Utiliser uniquement du charbon végétal dans le Grill Ouvert Mibrasa®.
- Lors du premier allumage du Grill Ouvert Mibrasa®, attendre au minimum une heure avant la mise en service.
- Utiliser le Grill Ouvert Mibrasa® avec vigilance. Il ne doit jamais être laissé sans surveillance ou déplacé pendant son fonctionnement.
- **PRECAUTION** Ne pas surcharger le Grill Ouvert. Consulter la table de charge du point 5.
- Les cendres doivent être déposées dans un récipient métallique. Ce récipient doit être placé dans un lieu loin des matériaux combustibles en attendant d'être vidé. Avant de vider le récipient, les cendres doivent refroidir complètement.
- Ne pas essayer d'éteindre les braises avec de l'eau.
- Ne pas nettoyer le Grill Ouvert lorsqu'il est chaud ou en marche.
- Lorsque le Grill Ouvert est chaud ou en marche, ne pas utiliser des produits chimiques pour nettoyer l'extérieur.

#### LES DANGERS

- Une mauvaise installation du Grill Ouvert peut provoquer un incendie. Suivre les instructions d'installation recommandées.
- Éloigner les enfants et les animaux domestiques du Grill Ouvert. Certaines parties accessibles du Grill Ouvert peuvent être très chaudes.
- Ne pas utiliser d'alcool, d'essence ou autres liquides similaires pour allumer ou raviver les braises. Utiliser seulement les pastilles allume-feux Ecofire Mibrasa®.
- Si le Grill Ouvert Mibrasa® est installé à l'extérieur, ne pas le couvrir avec une housse ni aucun autre produit inflammable lorsqu'il est en fonctionnement ou chaud.
- Revoir les restrictions du point 4.1 concernant les distances minimales des matériaux combustibles.

## 8. Conditions générales

---

### 8.1. Garantie

- Tous les Grills Ouvert Mibrasa® sont garantis 2 ans contre tout défaut de fabrication.
- Le client est responsable de l'installation, la mise en service et la maintenance du produit.
- La garantie est annulée en cas de:
  - (I) dommages causés par un mauvais usage ou mauvaise installation du produit,
  - (II) réparations, modifications ou réglages effectués par l'acheteur ou tierce sans l'autorisation préalable de Mibrasa®,
  - (III) défauts ou dommages non communiqués dans la période de garantie ci-dessus indiquée,
  - (IV) dommages dus à une négligence non attribuable à Mibrasa®, accident, mauvaise utilisation, installation inappropriée, mauvaise manipulation ou conditions anormales de température, humidité, salissure, corrosion ou toute autre cause extérieure à Mibrasa®.

### 8.2. Retours

- Le matériel retourné doit être en parfaite condition de conservation.
- Tous les retours doivent être notifiés par écrit et doivent être confirmés par notre service commercial.
- Tous les retours doivent être renvoyés à Mibrasa® aux frais du client et doivent être accompagnés de la facture et du numéro du bon de livraison.
- Les retours seront acceptés à condition que le four soit dans son emballage d'origine, non utilisé et à l'état neuf. Si le four est utilisé, obsolète ou abimé, il sera détruit sans aucun remboursement effectué.
- Pour tout retour, une décote de 10 % sera appliquée pour couvrir les frais de gestion.

### 8.3. Réserve de propriété

- Mibrasa® conserve la propriété des biens vendus jusqu'au paiement effectif de l'intégralité de leur prix.
- Mibrasa® se réserve le droit de modifier sans préavis ses produits et ses prix.



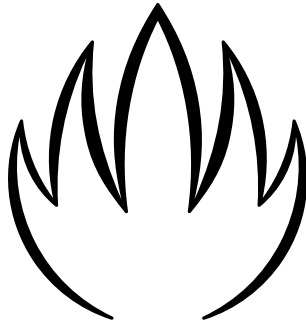

**MIBRASA®**

*The Craftsmen of Fire!*

8950 SW 74th Ct., Suite 1406  
Miami, Florida 33156

(408) 348-7607  
[www.mibrasa.com](http://www.mibrasa.com)  
[usa@mibrasa.com](mailto:usa@mibrasa.com)

Version 5.22